

8 7 6 5 4 3 2 1

D
C
B
A

D
C
B
A

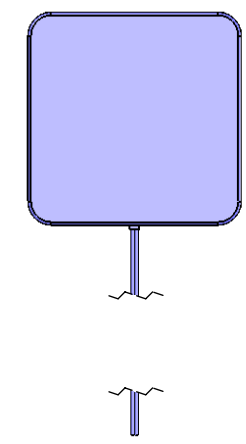
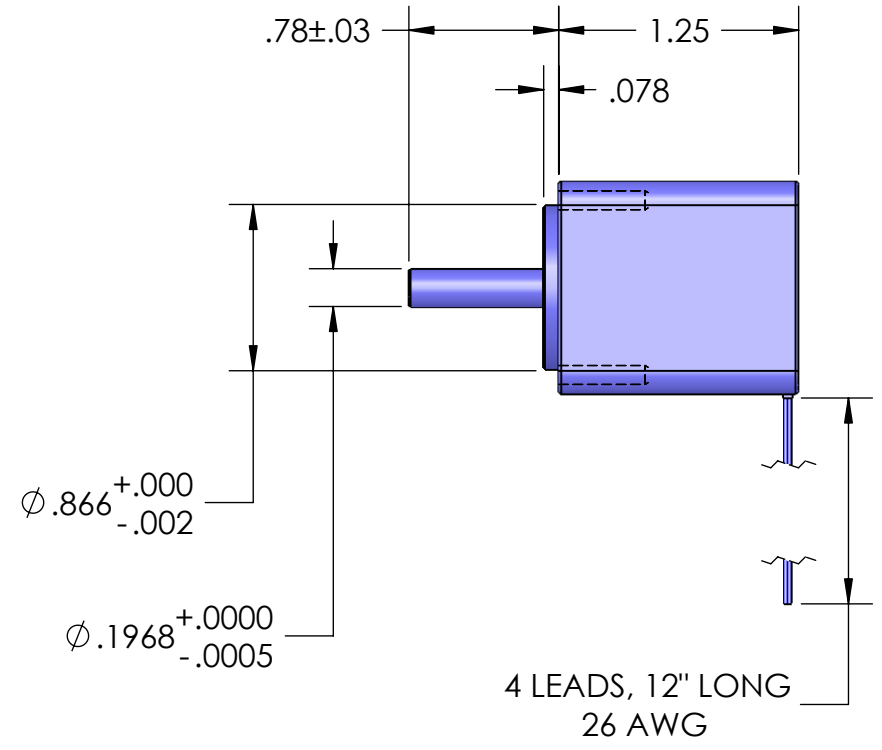
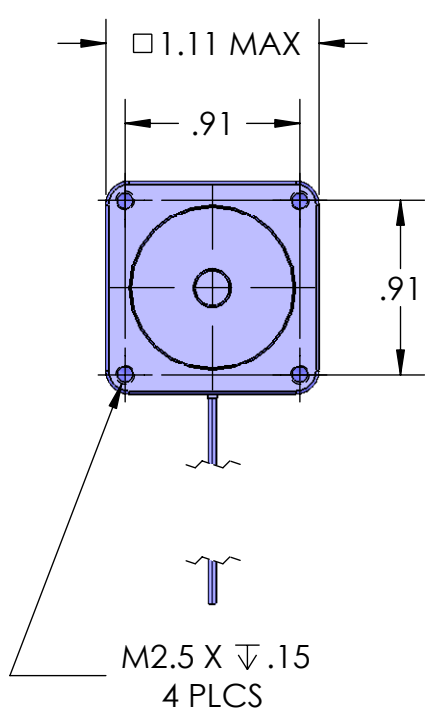

PROPRIETARY AND CONFIDENTIAL
THE INFORMATION CONTAINED IN THIS DRAWING IS THE SOLE PROPERTY OF USAUTOMATION ANY REPRODUCTION IN PART OR AS A WHOLE WITHOUT THE WRITTEN PERMISSION OF USAUTOMATION IS PROHIBITED.

		UNLESS OTHERWISE SPECIFIED:					
		DIMENSIONS ARE IN INCHES		DRAWN		NAME	
		TOLERANCES:		CHECKED		DATE	
		FRACTIONAL ±1/32		ENG APPR.			
		ANGULAR: MACH ±.5° BEND ±1°		MFG APPR.			
		TWO PLACE DECIMAL ±.03		Q.A.			
		THREE PLACE DECIMAL ±.005		COMMENTS:			
		INTERPRET GEOMETRIC TOLERANCING PER:					
		MATERIAL					
		FINISH					
NEXT ASSY	USED ON						
APPLICATION		DO NOT SCALE DRAWING					
				 23011 MOULTON PARKWAY, SUITE J2 LAGUNA HILLS, CA 92653 949-588-0581			
				TITLE: USS11T21XX-4S			
SIZE B		DWG. NO.		REV			
SCALE: 1:1		WEIGHT:		SHEET 1 OF 1			

8 7 6 5 4 3 2 1